

PROFESSIONAL KTV SYSTEMS

G SERIES _____

G-60C/G-60E

OWNER'S MANUAL _____

ENGLISH

ATTENTION

THANK YOU FOR PURCHASING THIS UNIT!

TO MAKE SURE FULL AND EFFECTIVE USE OF IT, PLEASE READ THIS MANUAL CAREFULLY BEFORE OPERATION. AND PLEASE SAVE THIS MANUAL FOR FUTURE REFERENCE.

IT'S POSSIBLE THAT THE SHAPE OF THE PLUGS AND JACKS ARE DIFFERENT IN DIFFERENT COUNTRIES, BUT THE CONNECTION WAYS AND OPERATION FOR THIS UNIT ARE THE SAME.

CONTENTS

	Voltage Input	4
INTRODUCTION	Features	5
	Signal Cords	5
	Front Panel(G-60C)	6
	Front Panel(G-60E)	7
	Back Panel	8
INSTALLATION	Before Connection	9
	System Connection	10
	Remote Control Unit	11
ADDITIONAL INSTRUCTION	Safety Regulations	12
	Specification	13

VOLTAGE INPUT

How to select right voltage input?

There's a voltage selector on the back panel of this unit and voltage intensity of this unit has been set between 220V originally.

Please check your local voltage intensity comply with this or not before operation. if not, you can select it between 110V by the voltage selector.

The power supply cord should be disconnected before adjusting the voltage input.

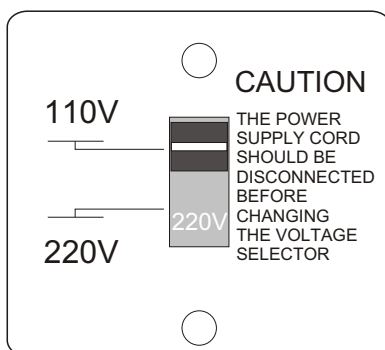

ACCESSORIES

There is a owner's manual in the package accompany with this unit, please check it when open the package.

INTRODUCTOIN

Please read this manual carefully before operation. And please save this manual for future reference.

FEATURES

- Inhibiting whistle strongly.
- Multi-mode singing style.
- Special design for KTV room, high reliability.
- Able to connect two group speakers simultaneously.
- Special drive design of human voice to make voice rich and nature
- strong cooling fan makes sure long-term working.

SIGNAL CONNECTION CORDS

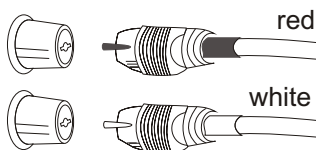

RCA plugs available

Note: RCA plug in red should insert into jack in red.

RCA plug in white should insert into jack in white.

FUNCTION INSTRUCTIONS (FRONT PANEL)

G-60C

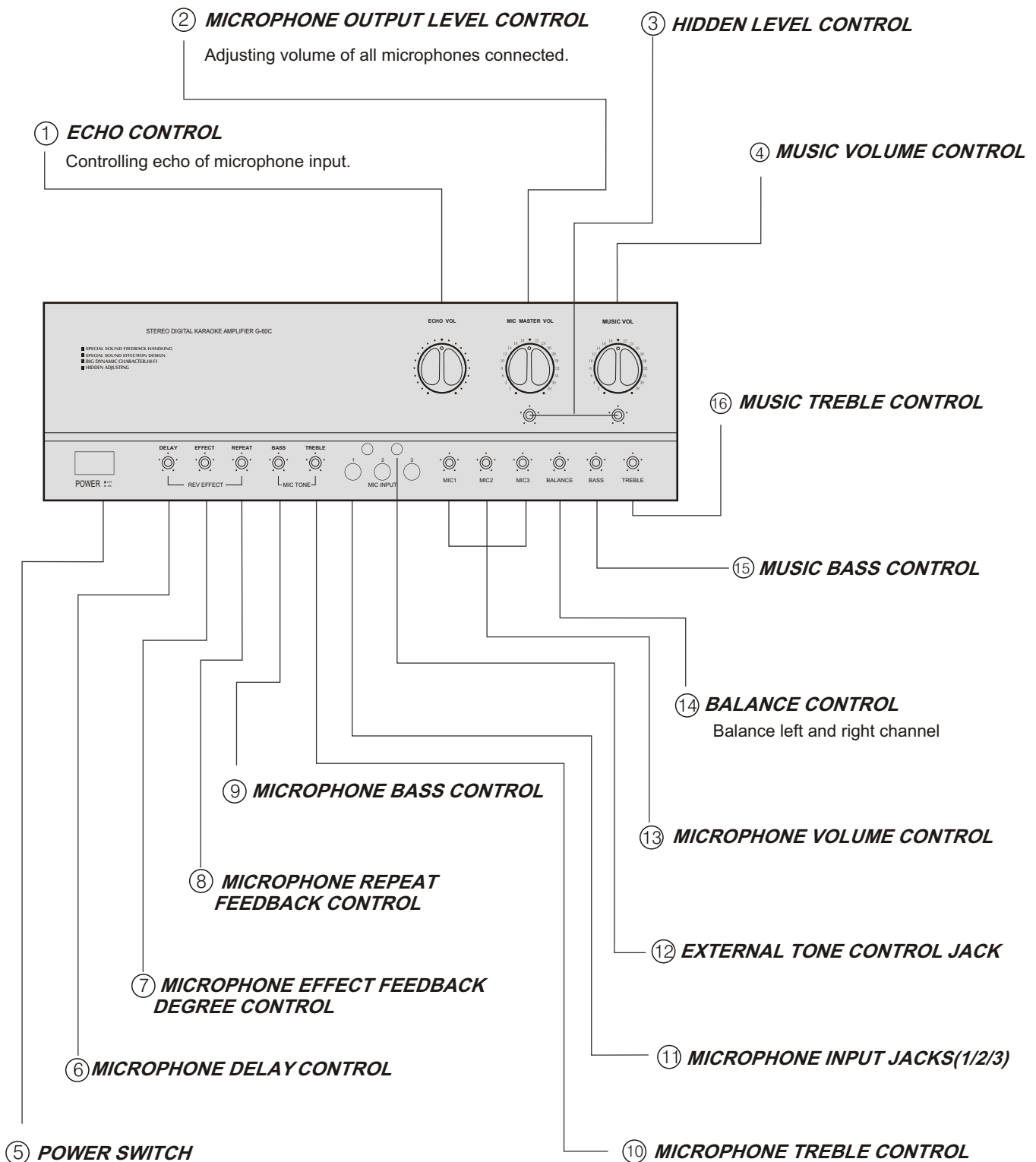

FUNCTION INSTRUCTIONS (FRONT PANEL)

G-60E

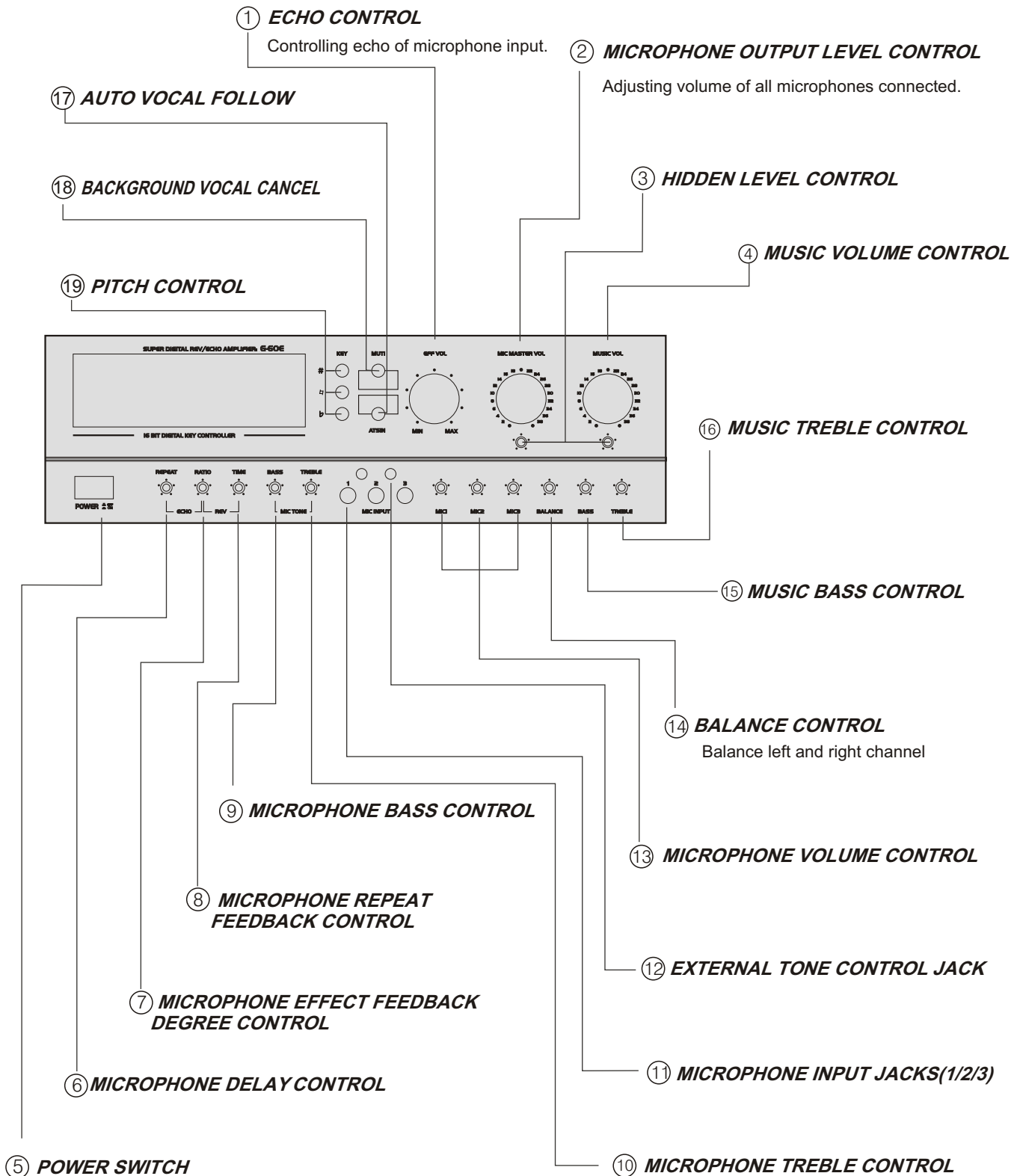

BACK PANEL

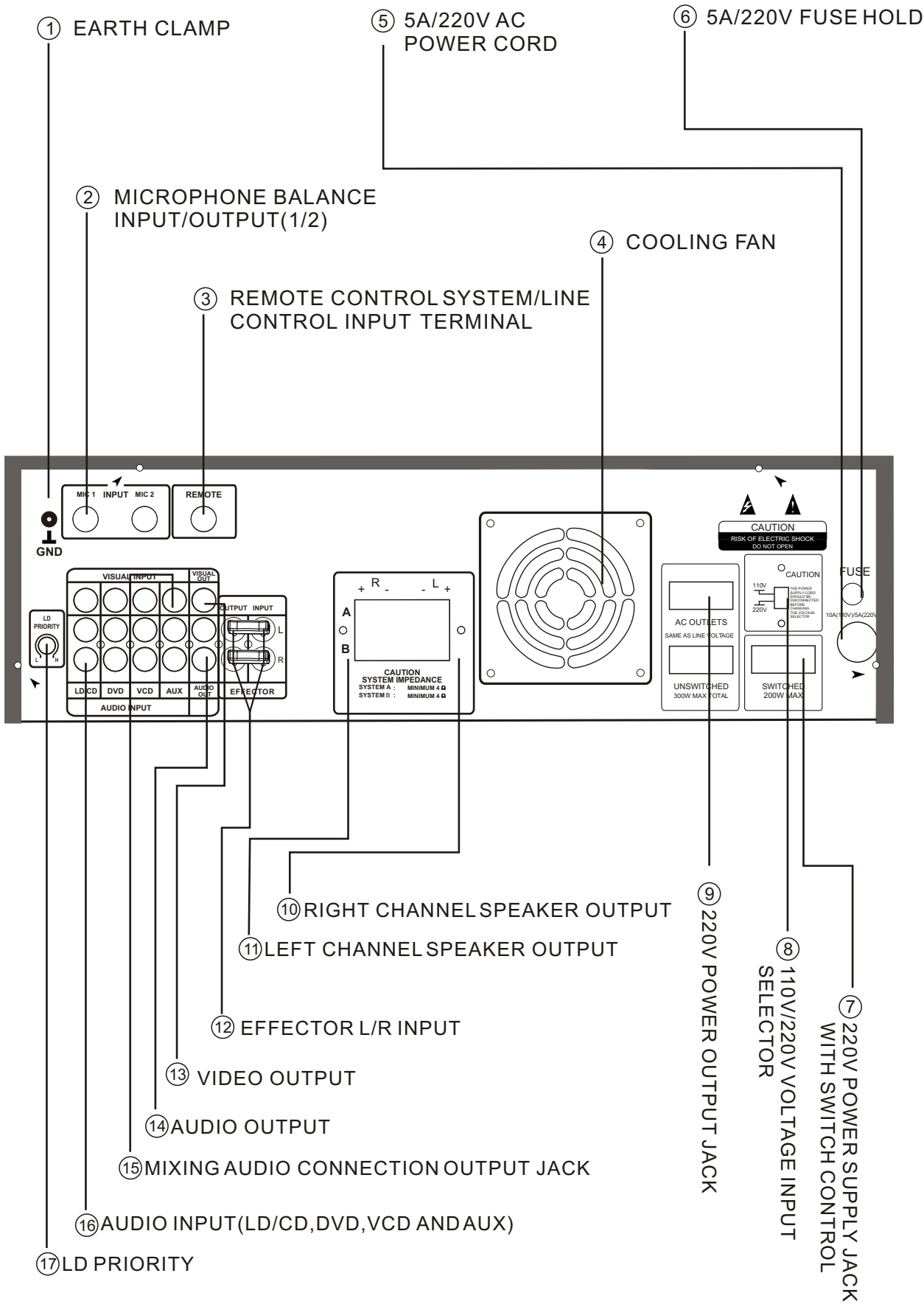

CONNECTIONS

BEFORE CONNECTION

CONNECTION OF SPEAKER CORDS

1. Press down the button as illustration, insert the cords into the hole.
2. Spring of the button will fix the cords.
Please select the suitable speaker cords and connect it through the shortest path.

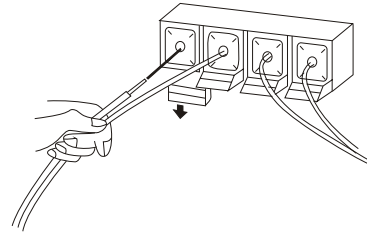

This unit could connect one or two group speakers simultaneously. If only connect one group speakers, you can select connect group A or group B. And please note that phase of the speaker cords are correct or not, if not, the sound will be felt unnatural and absence of low frequency.

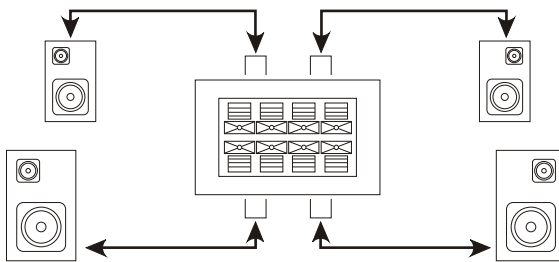

Attention: ends of the cords should not touch each other.

SYSTEM CONNECTION

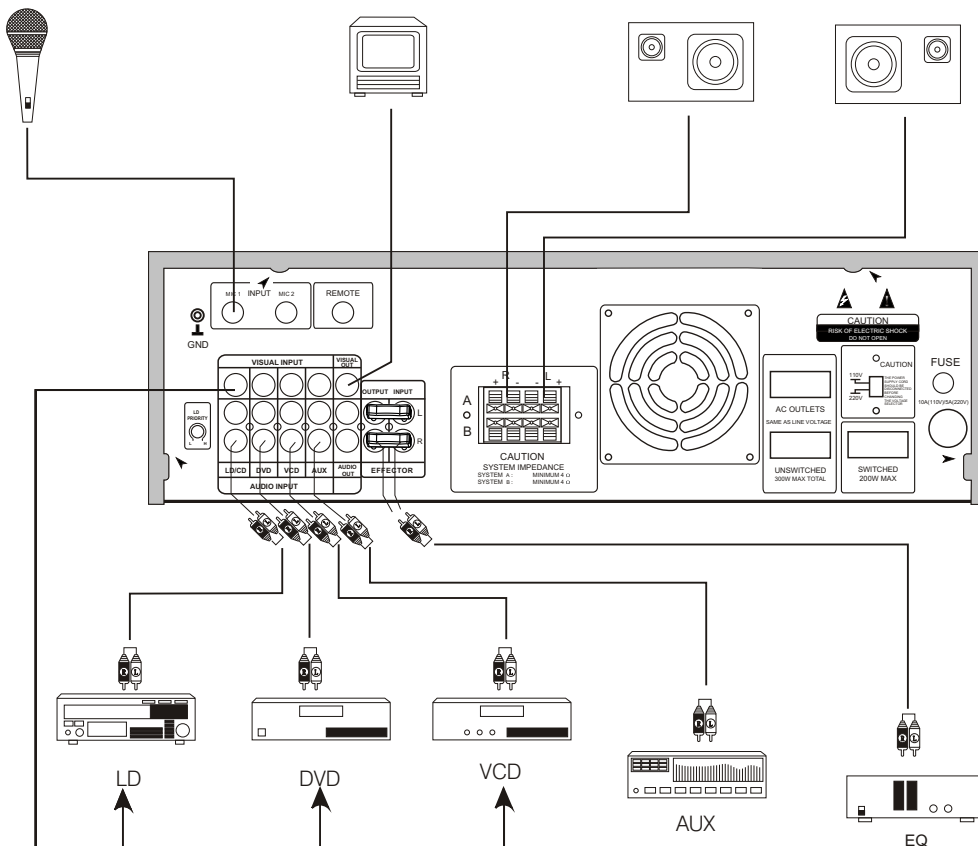

CONNECTIONS

REMOTE CONTROL UNIT

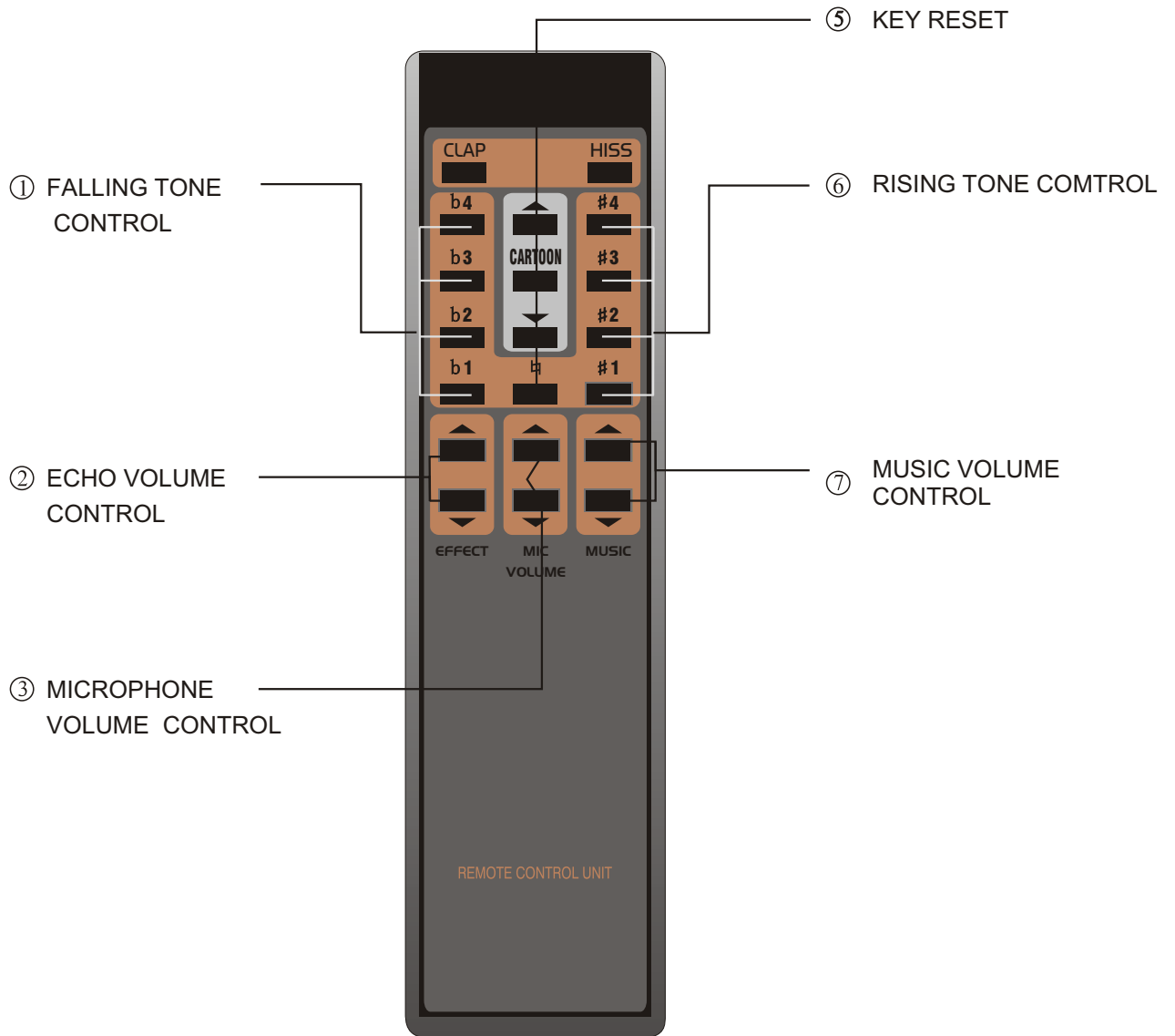

ADDITIONAL INSTRUCTION

SAFETY REGULATIONS

ABNORMAL PHENOMENA:

Please turn off the power and pull out the plug when you find unusual sound or smell when operation.

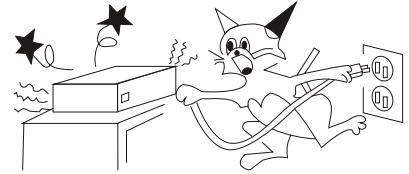

POWER CORDS PROTECTION

Don't touch power cords with wet hands to avoid electric shock.
Don't put the cords in crowded people.

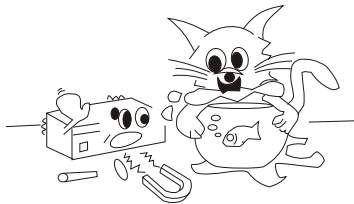

KEEP AWAY FROM WATER AND SUNDRY GOODS



DON'T OPEN THE COVER IF NOT GUIDED BY A QUALIFIED ELECTRICIAN

PULL OUT THE POWER CORDS TO AVOID FIRE WHEN YOU DON'T USE THIS UNIT.

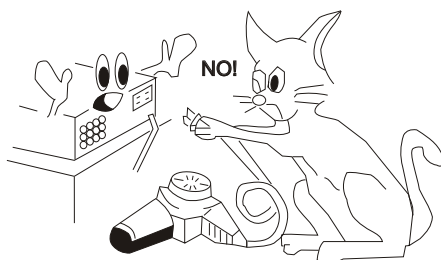
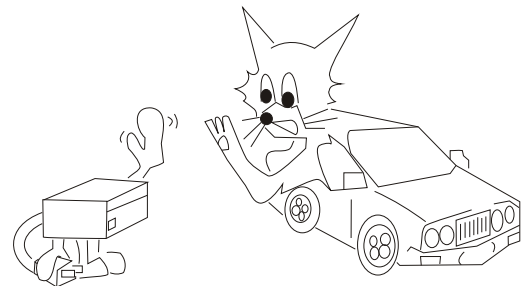

DON'T OVERLOAD IT

SPECIFICATIONS

Cosmetic changes may be made

Power Output(RMS)

G-60C	125W+125W(80hm)
G-60E	125W+125W(80hm)
THD 0.3% 20Hz-20KHz	

Frequency Response 20Hz-20KHz \pm 2dB

Input Sensitivity/Impedance

Microphone	0.5mv-100mv/2KOhm
Line	0.707v/51KOhm
Video	1Vp-p/75Ohm

Pitch Control

Music	
Bass(Gain/Attenuation)	\pm 12dB
Treble(Gain/Attenuation)	\pm 12dB

Microphone

Bass(Gain/Attenuation)	\pm 12dB
Treble(Gain/Attenuation)	\pm 6dB

Output Sensitivity/Impedance

Audio	0.707V/1KOhm
Vedio	1Vp-p/75Ohm

Short Circuit Protection

Output Impedance	2-16Ohm
Recommendatory Impedance	80hm

Power Supply AC 110V-220V/50Hz

Standard Power Supply AC 220V/50Hz

Power Consumption

G-60C	380W
G-60E	380W

AC Power Outlets

Switched	200W
Unswitched	300W

Static Power Consumption

G-60C	20W
G-60E	20W

Net Weight

G-60C	10.5KG
Gross Weight	12 KG
G-60E	12 KG
Gross Weight	13.5KG

Dimensions 495x426x190(MM)

KARAOKE AMPLIFIER